



5/1/2006

VISIT THE LIFETIME WEB SITE:
WWW.LIFETIME.COM

**** Do Not Contact the Store ****
For Assistance, including missing or broken parts,
Call Customer Service at:
1 (800) 225-3865

30" Shed Extension Kit

MODEL #6424

ASSEMBLY
INSTRUCTIONS AND
OWNER'S MANUAL

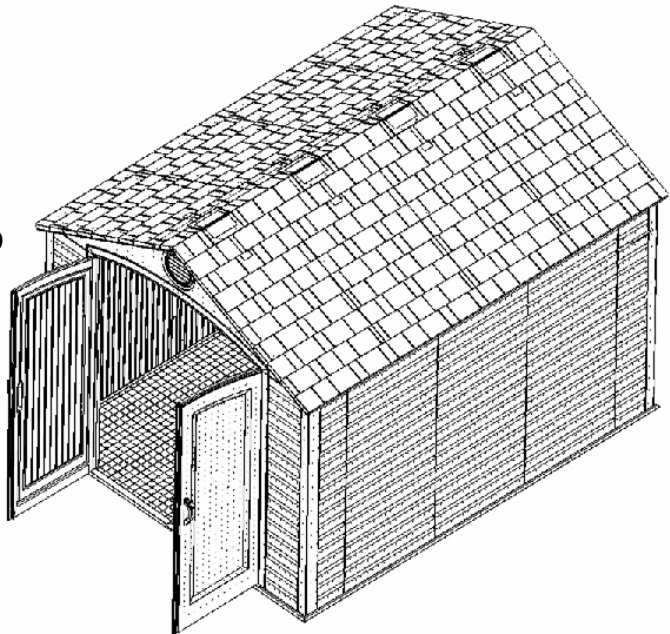

Save this instruction in the event that the manufacturer has to be contacted for replacement parts.

INSTRUCTION #1012324



VISIT THE LIFETIME WEB SITE:
WWW.LIFETIME.COM

**** Do Not Contact the Store ****
For Assistance, including missing or broken parts,
Call Customer Service at:
1 (800) 225-3865

Hillcrest
30" Shed Extension Kit w/ Window
MODEL #6424

ASSEMBLY
INSTRUCTIONS AND
OWNER'S MANUAL

****A MINIMUM OF TWO ADULTS ARE REQUIRED FOR ASSEMBLY****

STOP! BEFORE BEGINNING ASSEMBLY **STOP!**
Identify and inventory all parts using the checklist boxes on the Parts List. Keep the hardware bags and their contents separate. If any parts are missing, call our Customer Service Department.

SAFETY INSTRUCTIONS
Failure to follow these safety instructions may result in serious injury or property damage. Proper and complete assembly, use and supervision is essential for proper operation and to reduce the risk of accident or injury. A high probability of serious injury exists if this display is not installed, maintained, or operated properly. • If using a ladder during assembly, use extreme caution. Follow all warnings and cautions on the ladder carefully. • 2 people are required for assembly. • Misuse could result in system failure. • If technical assistance is required, contact the manufacturer.
Most injuries are caused by misuse and/or failure to follow instructions.

PARTS LIST

ID	Part #	Description	Qty
108	ZS10882	Wall Panel	1
125	ZS12582	Window Wall Panel	1
110	CB11099	Center Floor Panel	1
114	CB11480E	Lower Roof Panel	2
117	CB11780C	Center Roof Cap	1
AA	CH08580	Skylight	1
AB	AR02406	Roof Truss Channels	2
AC	1001866	Roof Truss Brace	1
AD	ZS01006	Roof Support	2
AE	ZS01200	Window	1
Hardware Bag [1005273]			
TA	1001865	Truss Connector	1
TB	BB04500	Threaded Rod	1
TD	BN00300	1/4" Cap Nut	2
TE	BN01600	#10 Cap Nut	6
TF	BS06100	#10 x 3/8" Pan-Head Screw	8
TH	BS07500	.25" x .625" Screw	45
TI	BS05900	#10 x .5" Pan-Head Screw	6
TJ	BW01200	#10-1" Fender Washer	6
TK	1007360	Window Latch	2

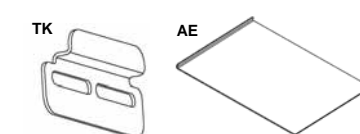
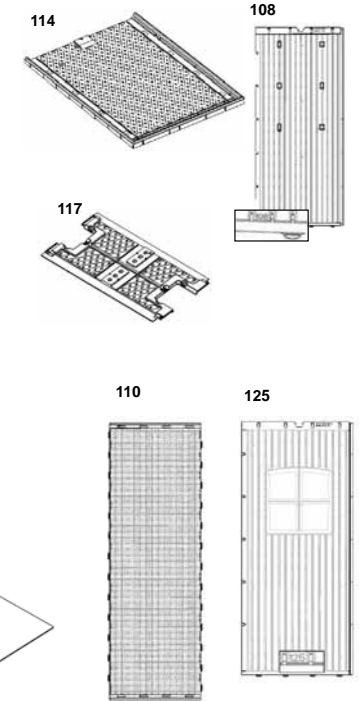

Save this instruction in the event that the manufacturer has to be contacted for replacement parts.

HARDWARE IS ACTUAL SIZE

(unless otherwise indicated)

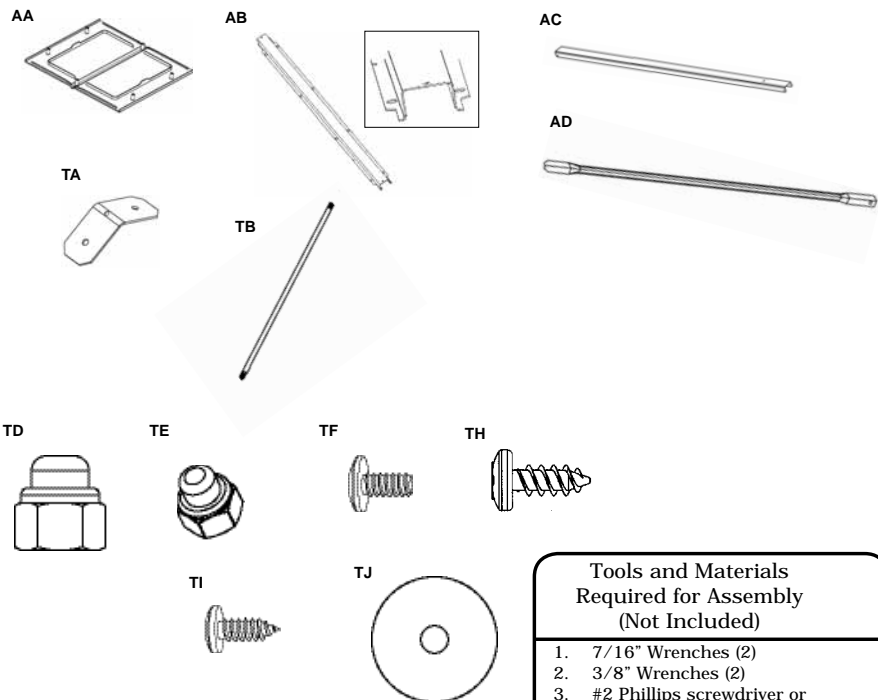

Tools and Materials Required for Assembly (Not Included)

1. 7/16" Wrenches (2)
2. 3/8" Wrenches (2)
3. #2 Phillips screwdriver or
Electric drill with phillips head

If you are Installing a New Shed

1. Check contents of boxes and compare to parts listed on the Parts List.
2. Follow instructions that came with your shed, but add extra floor panel, wall panels, Roof Cap and Skylight at appropriate points in the assembly.

If you are Extending an Existing Shed

1. Remove any objects from back shelves.
2. Remove any shelves, pegboards, or other objects hanging on the last two Side Wall Panels on either side.
3. Check contents of boxes and compare to parts listed on the Parts List.
4. Follow the steps in this manual.
5. If you are extending an 8' x 5' shed you will need to modify the following instructions by not removing as many parts as shown in the illustrations.

****Save all hardware for re-assembly!****

1

- a. Remove last three skylights.

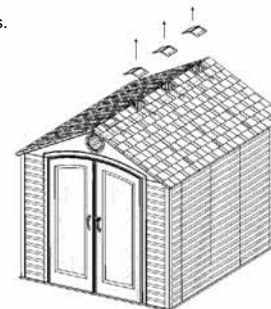

2

- a. Remove the back 3 roof caps.

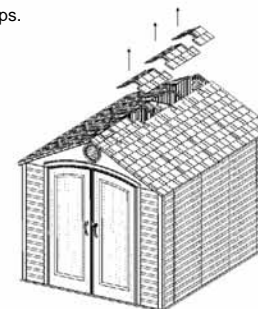

3

- a. Remove the back Roof panels and Roof support bars.

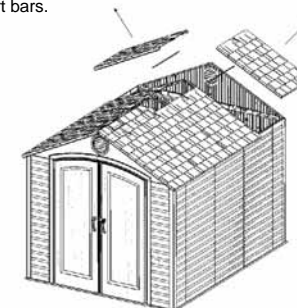

4

- a. Remove the next Roof panels and Roof support bars.

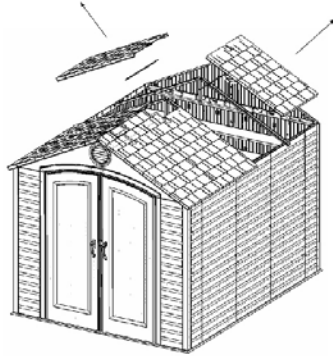

5

- a. Remove the Roof Truss.

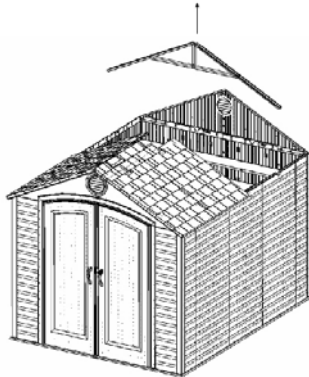

6

- a. Remove the last two Side Wall Panels.

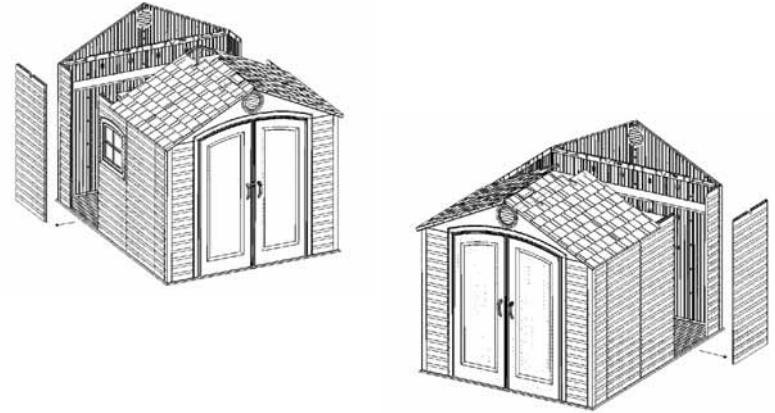

7

- a. Slide the back section of the shed away from the front. You will need to tip the back section forward slightly in order to disconnect the floor panels.

Be sure that there is nothing on the back shelves before moving this back section.

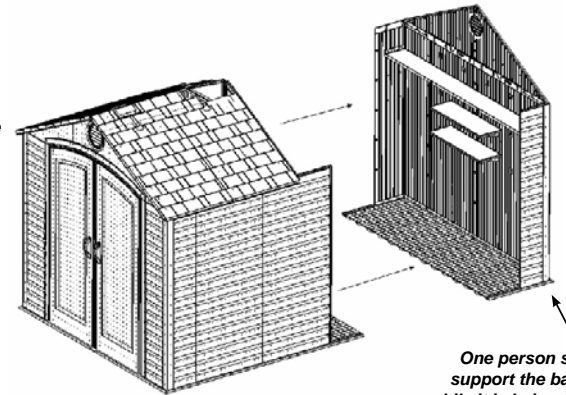

One person should support the back wall while it is being tipped and moved.

8 Assemble Window

- a. Remove plastic sheeting from Window (AE) and slide Window into slot on the Window Wall Panel (125). Attach a Window Latch (TK) above each corner of the Window as shown. When tightening screws (TH), be sure that Window Latches will slide freely. Do not overtighten. Insert screw (TF) into the hole in the window. Set panel aside.

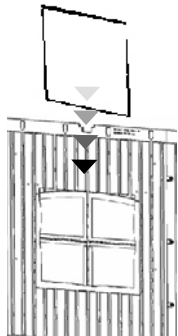
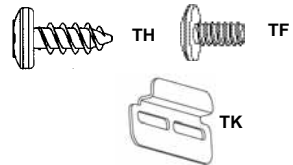

Insert window with bent edge at top and pointing away from the wall.

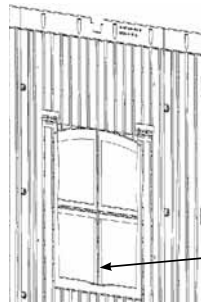

Place screw (TF) in this hole to keep window from sliding up too far. Insert until flush with the window

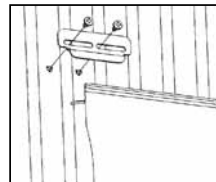
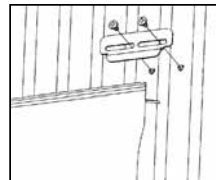

9

- a. Add new floor panel. Then, slide the back section into place and connect the floor panels (you will need to tip the panels forward slightly to connect the panels).

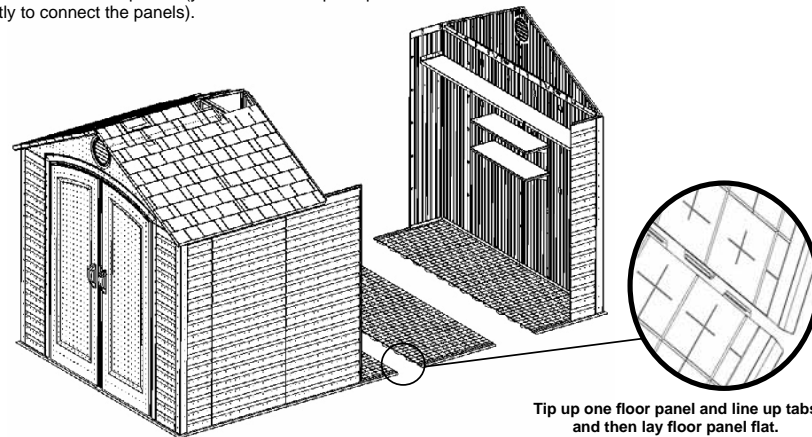

Tip up one floor panel and line up tabs and then lay floor panel flat.

10

- a. Add Wall panels.

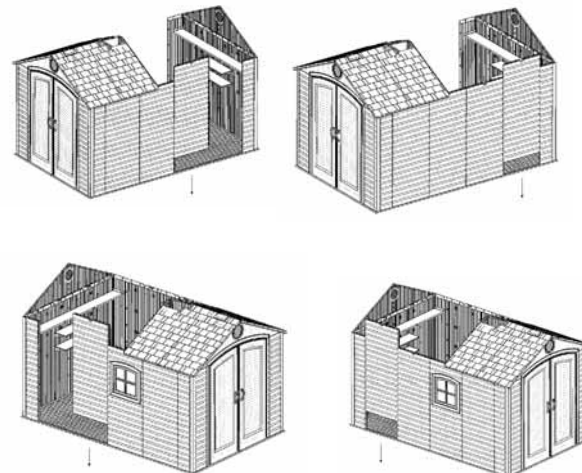

Insert a wood block directly under the tab you want to insert, then slide block to next tab and repeat.

11 Assemble Truss

a. Attach Brace (AC) to two Roof Truss Channels (AB) (one on each side of Brace). Secure Brace with screws (TF) and nuts (TE).



Follow picture above to connect Brace to a Truss Channel at each end of the Brace.

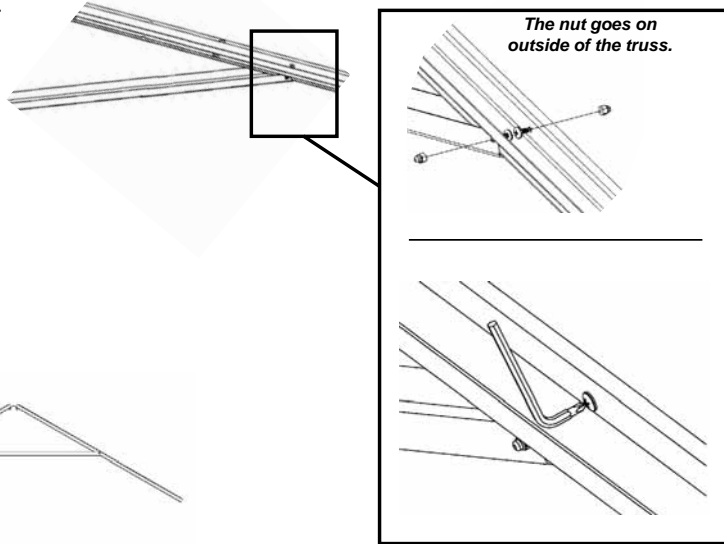

b. Use Truss Connector (TA) to attach Roof Truss Channels at top. Secure with screws (TF) and nuts (TE). Before completely tightening, lay assembly on its side to be sure Channels and Brace are parallel. Completely tighten all hardware.

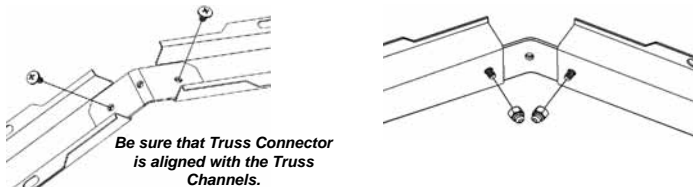

c. Slide a Threaded Rod through the Truss Support Brace and the top of the Truss Connector.

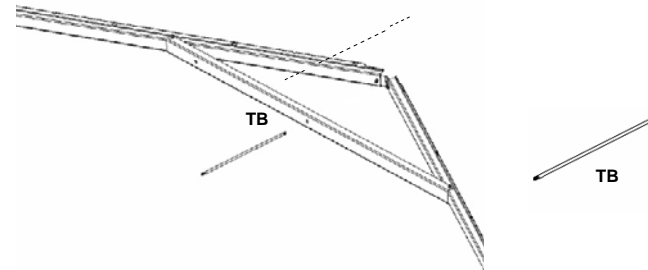
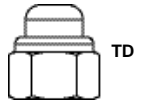

d. Secure the top and bottom of the Threaded Rod with a 1/4" Cap Nut (TD).

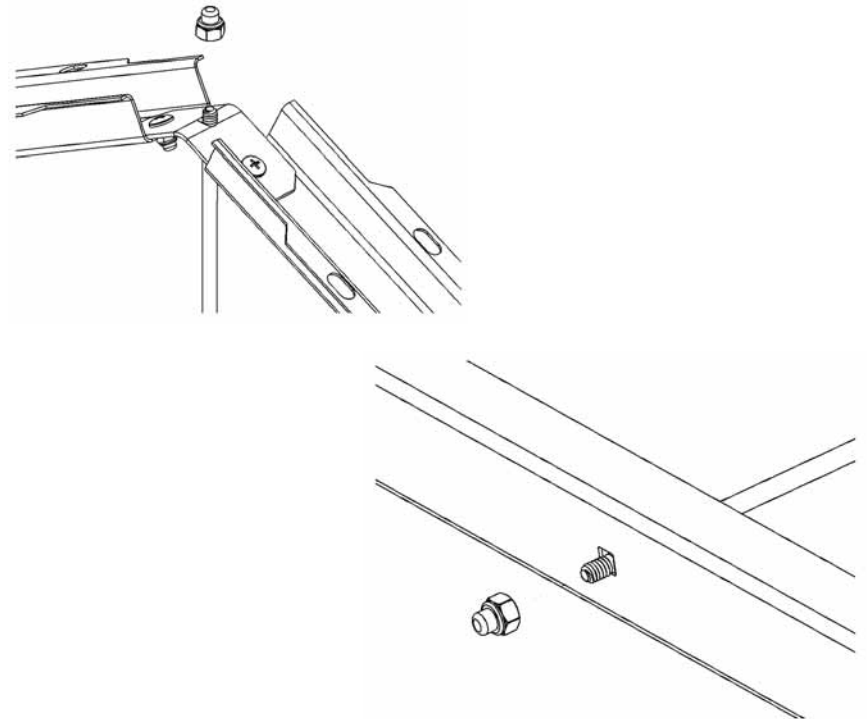

12

a. Add Truss.

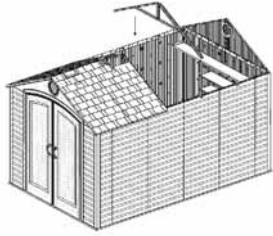

13

a. Add Roof panels and Roof Supports.

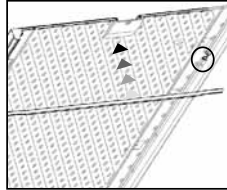
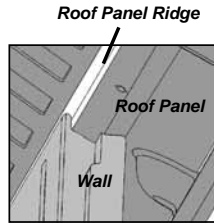
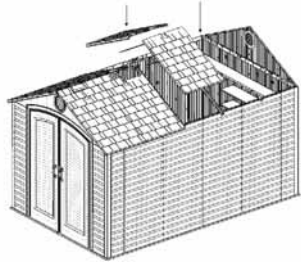

b. Add a center Roof Cap.

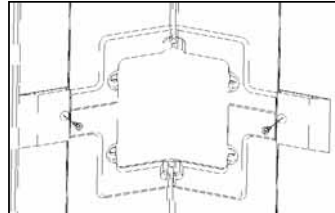
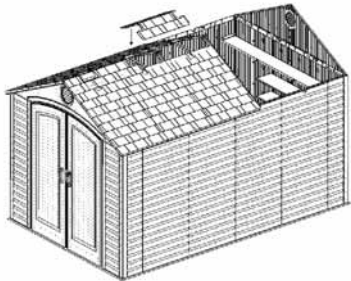

14

a. Add Truss.

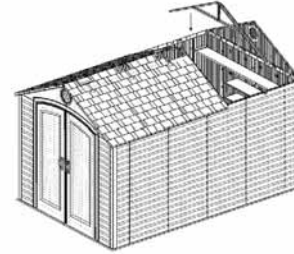

15

a. Add Roof panels and Roof Supports.

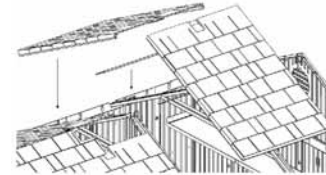

b. Add a center

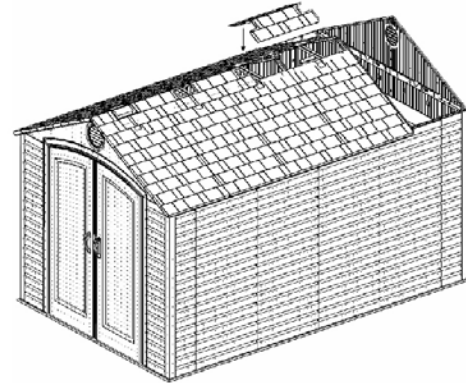

16

a. Add Roof panels and Roof Supports.

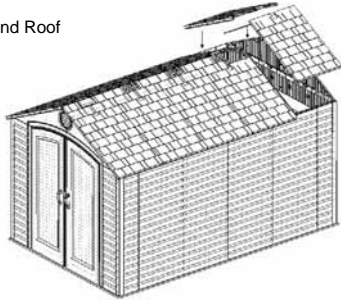

b. Add the last Center Roof Cap and the End Roof Cap.

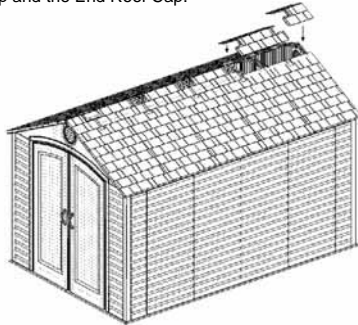

17

a. Add Skylights

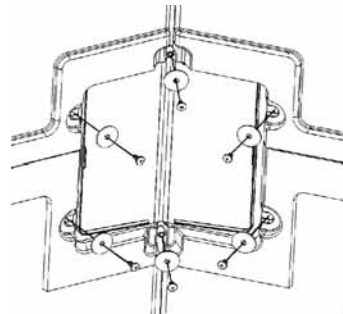
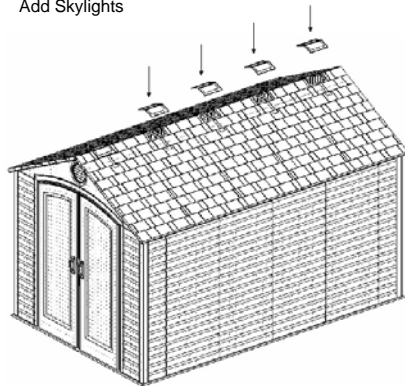

Enhance your Lifetime® Outdoor Shed by purchasing the following Shed Accessories:

Model #

0110

Corner Shelf (2 pack)

Two 10" radius shelves with hardware.

0130

32" Shelf Kit w/ hardware (3 pack)

Three 32" x 10" Steel-Reinforced Shelves with shelf brackets and hardware.

0150

8' Shelf Kit w/ hardware

One 96" x 9" Steel-Reinforced Shelf with shelf bracket and hardware.

0170

Pegboard w/ hardware

One 22.5" x 22.5" Pegboard Panel with hooks. Great for hanging large and small items such as: rakes, shovels, and hand tools.

0190

Shelf Support Channel

Two Shelf Support Channels that allow the 32" shelves on either of the side walls of your shed.



0110

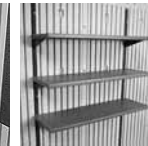

0130



0150



0170

**To purchase shed accessories,
visit us at:**

www.buylifetime.com

**Or call:
1 (800) 424-3865**

Congratulations on your Lifetime® Outdoor Shed purchase. By following the instructions below, your new Lifetime shed should provide you with years of service and enjoyment.

Cleaning and Care

The polyethylene walls and shelves are stain- and solvent resistant. To clean, use a mild soap and a soft-bristled brush. Abrasive cleaning materials may scratch the plastic and are not recommended. Repair scratches or rust spots on the metal by Sanding the affected area lightly; using a rust preventative spray primer; and finally, spraying with a high-gloss spray enamel paint. Avoid placing a direct heat source on or near surfaces unless using a heat barrier.

**For warranty details or to register your product, visit
www.lifetime.com or call 801-776-1532**